

Technical Data/ Technische Daten

Cross adapter AK II A

Kreuzschienenverbinder AK II A

description/ Artikelbezeichnung:





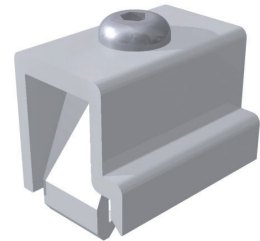

Cross Adapter AK II A/ Kreuzschienenverbinder AK II A

art.-no./ Artikelnummer:

30-500-047

Product Data/ Artikeldaten

 material identification/ Werkstoffbezeichnung: EN AW-6063 T6
 (EN AW-AMg0,7Si)

mechanical values/ Mechanische Werte:

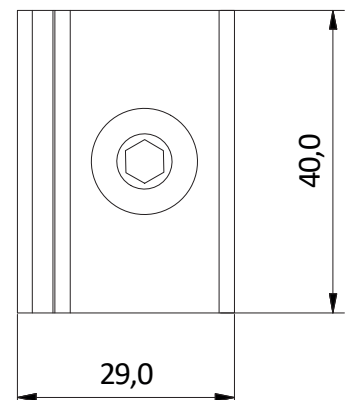
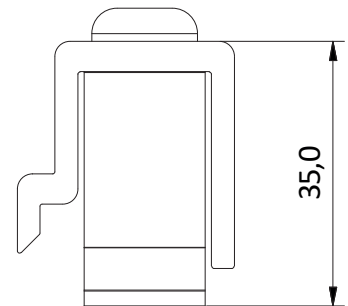
F_{rd} suction/Sog	=	500 N	
F_{rd} transverse shear/Schub quer	=	225 N	
F_{rd} parallel shear/Schub parallel	=	225 N	
F_{rd} suction/Sog	=	3670 N	
F_{rd} transverse shear/Schub quer	=	2100 N	
F_{rd} parallel shear/Schub parallel	=	902 N	
F_{rd} suction/Sog	=	7140 N	
F_{rd} transverse shear/Schub quer	=	2400 N	
F_{rd} parallel shear/Schub parallel	=	5000 N	
F_{rd} suction/Sog	=	9000 N	
F_{rd} transverse shear/Schub quer	=	- N	
F_{rd} parallel shear/Schub parallel	=	- N	

general values/ Allgemeine Werte:

width/Breite	=	29,00 mm
height/Höhe	=	35,00 mm
weight/Gewicht	=	0,048 kg
length/Länge	=	40,00 mm

notice/ Hinweise:

tightening torque: 8 - 10 Nm (M8x20)/ Anzugsmoment: 8-10 Nm (M8x20)

static values of the items on request/ Statische Werte der Einzelteile auf Nachfrage!

screw fitting/ Verschraubung:

Flat head screw M8x20 ISO 7380 A2-70 A AF5/ Flachkopfschraube M8x20 A2-70 A ISO 7380 SW5

Square nut M8 low form DIN 562 A2-50/ 4kt Mutter M8 niedrige Form DIN 562 A2-50